

Data Sheet



Article number: 51803228000010

Description: Vibration damper GP-QP 50x40
NR shore 57

Measures

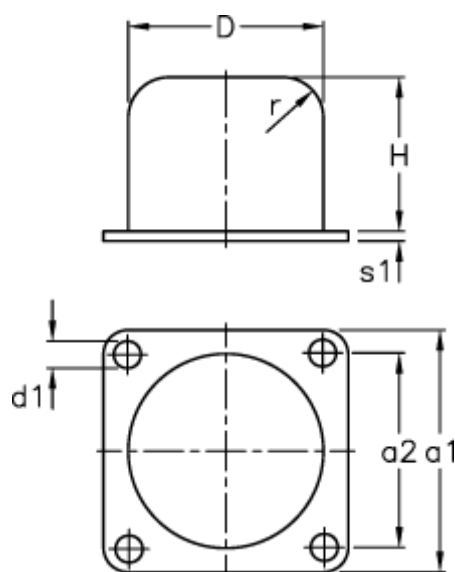

a1	= 63	r = 10.0
a2	= 50	s1 = 3
D	= 50	
d1	= 6.5	
H	= 40	
Load capacity F (kN)	= 24.0	
Load capacity f (mm)	= 22	
Load capacity W (J)	= 140	